



# MIG155GD



**Operator's Manual**

**LINLONG LIMITED**  
[www.weldpro.com](http://www.weldpro.com)

**THANK  
YOU**

**for your  
purchase!**



Take a moment and subscribe to our youtube channel. Weldpro is committed to releasing lots of tutorial and how-to videos to help you fine tune your welding skill.



Dear Valued customer,

We at Weldpro would like to thank you very much for being our valued customer. We take great pride in providing quality welding equipment at an affordable price.

As an experienced welder, your feedback (no matter positive or negative) will be an important factor for us to improve the quality of our product and our customer service. We would greatly appreciate if you would take a moment to provide feedback for the product that you purchased.

Weldpro is always there to assist you should you have any questions.

Sincerely, your friends at Weldpro!



**Linlong Limited**

1307 West Valley Highway North, Suite 103, Auburn, Washington 98001  
www.weldpro.com Tel:253-329-2179

**Technical support: 651 329 2686**

Email: support@weldpro.com



## IMPORTANT

**For any questions, concerns, or  
problems contact Weldpro**

**Support directly at  
651-329-2686**



## Introduction

Thank you for purchasing the Weldpro MIG155GD welder. This welder is designed and built using the very best quality components to afford a great welding experience and great performance.

This manual contains the description of the hardware and the operating instructions of the equipment. For your safety and that of others, please read this manual carefully.

## Attention

Pay attention to the words following the signs below.

Sign	Description
 <b>DANGER</b>	The word following this sign means that there is great potential danger, which may cause a major accident, damage or even death, if the instructions are not followed.
 <b>WARNING</b>	The word following this sign means that there is some potential danger, which may cause bodily injury or property damage, if the instructions are not followed.
 <b>ATTENTION</b>	The word following this sign means that there is potential risk, which may cause malfunctions and/or breakdowns, if the instructions are not followed.

## Edition

The contents of this manual are updated regularly in order to include all product updates. The manual is to be used solely as a user's guide, except where indicated otherwise. No warranties of any kind, whether expressed or implied are made in relation to the information, descriptions, suggestions or any other content of the manual.

The images of this manual are for reference only. If there is any inconsistency between the image and the actual product, the actual product will govern.

# CONTENTS

- 1 WELDPRO SAFETY ..... 5
- 2 PRODUCT DESCRIPTION..... 17
- 3 THREE YEARS WARRANTY..... 18
- 4 TECHNICAL PARAMETERS..... 19
- 5 GENERAL WELDING FACTS..... 20
- 6 ELECTRICAL VOLTAGE..... 21
- 7 INSTALLATION..... 22
- 8 OPERATION..... 30
- 9 DAILY CHECKING ..... 32
- 10 TROUBLESHOOTING..... 33

For Arc  
Welding  
and Cutting  
like a  
Weldpro



Thank you for using Weldpro arc welding and cutting equipment.

We ask you to work like a weld-pro and weld-pros weld and cut safely. Please read and comply with the sample safety procedures outlined in this guide and the equipment Owner's Manual.



Always read and follow the Owner's Manual, the safety labels on the product, and all applicable safety standards, especially ANSI Z49.1, Safety in Welding, Cutting, (we recommend you get a copy and keep it handy).



Only qualified persons should install, operate, maintain, and repair this equipment. A qualified person is defined as one who, by possession of a recognized degree, certificate, or professional standing, or who by extensive knowledge, training and experience, has successfully demonstrated the ability to solve or resolve problems relating to the subject matter, the work, or the project and has received safety training to recognize and avoid the hazards involved.

Thank you for working safely.

---

1	General Safe Practices.....	7
2	Arc Welding Hazards.....	7-9
3	Plasma Arc Cutting Hazards.....	10-12
4	Special Situations & Equipment.....	13-14
5	EMF Information.....	14-15
6	California Proposition 65 Warnings.....	15
7	Principal Safety Standards.....	15
8	Lens Shade Selector Guide.....	16

## 1. General Safe Practices

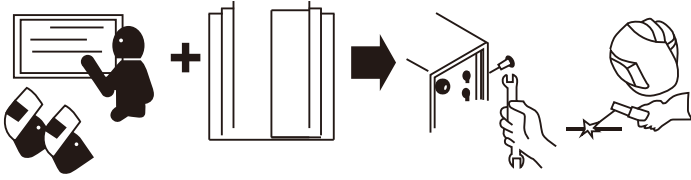

Become trained and read the instructions before working on the machine or welding or cutting. Read and understand the Safety Data Sheets (SDSs) and the manufacturer's instructions for adhesives, coatings, cleaners, consumables, coolants, degreasers, fluxes, and metals.

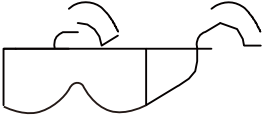

Wear approved safety glasses with side shields under your welding helmet or face shield and at all times in the work area.

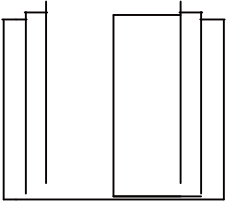

Read and follow all labels and the Owner's Manual carefully before installing, operating, or servicing unit. Read the safety information at the beginning of the manual and in each section.

Wear a safety harness if working above floor level. Keep children away from all equipment and processes.

Do not install or place machine on or over combustible surfaces.

Use GFCI protection when operating auxiliary equipment in damp or wet locations.

Use only genuine replacement parts from the manufacturer.

Perform installation, maintenance, and service according to the Owner's Manuals, industry standards, and national, state, and local codes.

## 2. Arc Welding Hazards



**Electric shock from welding electrode or wiring can kill.**

Wear dry, hole-free insulating gloves and body protection. Do not touch electrode with bare hand. Do not wear wet or damaged gloves.

Do not touch live electrical parts.

Do not use AC weld output in damp, wet, or confined spaces, or if there is a danger of falling.

Use AC output ONLY if required for the welding process.

If AC output is required, use remote output control if present on unit. Do not use worn, damaged, undersized, or repaired cables.

Additional safety precautions are required when any of the following electrically hazardous conditions are present: in damp locations or while wearing wet clothing; on metal structures such as floors, gratings, or scaffolds; when in cramped positions such as sitting, kneeling, or lying; or when there is a high risk of unavoidable or accidental contact with the workpiece or ground. For these conditions, use the following equipment in order presented: 1) a semiautomatic DC constant voltage (wire) welder, 2) a DC manual (stick) welder, or 3) an AC welder with reduced open-circuit voltage.

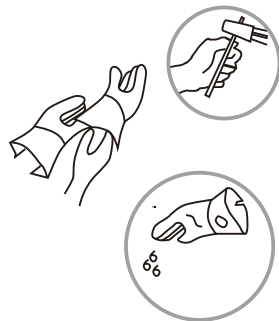



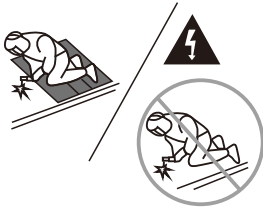

Protect yourself from electric shock by insulating yourself from work and ground. Use non-flammable, dry insulating material if possible, or use dry rubber mats, dry wood or plywood, or other dry insulating material big enough to cover your full area of contact with the work or ground and watch for fire.

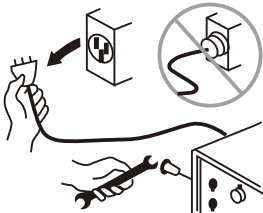

Disconnect input plug or power before working on machine. Do not make input connections if color blind.

Frequently inspect input power cord and ground conductor for damage or bare wiring – replace immediately if damaged – bare wiring can kill. Keep cords dry, free of oil and grease, and protected from hot metal and sparks. Be sure input ground wire is properly connected to a ground terminal in disconnect box or receptacle.

Properly install, ground, and operate all equipment according to its Owner's Manual and national, state, and local codes.



**Breathing welding fumes can be hazardous to your health.**



Keep your head out of the fumes. Do not breathe the fumes. Use enough ventilation, exhaust at the arc, or both, to keep fumes and gases from your breathing zone and the general area. The recommended way to determine adequate ventilation is to sample for the composition and quantity of fumes and gases to which personnel are exposed.

Read and understand the Safety Data Sheets (SDSs) and the manufacturer's instructions for adhesives, coatings, cleaners, consumables, coolants, degreasers, fluxes, and metals.



Use enough forced ventilation or local exhaust (forced suction) at the arc to remove the fumes from your breathing area.



Use a ventilating fan to remove fumes from the breathing zone and welding area. If adequacy of ventilation or exhaust is uncertain, have your exposure measured and compared to the Threshold Limit Values (TLV) in the Safety Data Sheet (SDS).



**Welding can cause fire or explosion.**



Do not weld near flammable material or where the atmosphere can contain flammable dust, gas, or liquid vapors (such as gasoline). Move flammables at least 35 feet (11 meters) away or protect them with flame-proof covers (see NFPA 51B listed in Section.



Welding sparks can cause fires. Have a fire extinguisher nearby and have a trained fire watcher ready to use it. After completion of work, inspect area to ensure it is free of sparks, glowing embers, and flames.



Do not weld on containers that have held combustibles, or on closed containers such as tanks, drums, or pipes unless they are properly prepared according to AWS F4.1 and AWS A6.0 (see Safety Standards in Section 9).



**Welding can cause fire or explosion.**

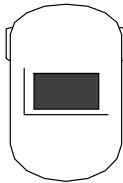

Use welding helmet with correct shade of filter (see Section to choose the correct shade).



Wear welders cap and safety glasses with side shields. Use ear protection when welding out of position or in confined spaces. Button shirt collar.

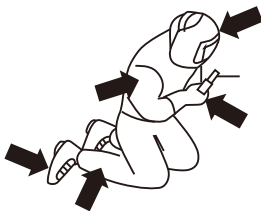

Wear body protection made from durable, flame-resistant material (leather, heavy cotton, wool). Body protection includes oil-free clothing such as leather gloves, heavy shirt, cuffless trousers, high shoes, and a cap.



**Moving parts can injure.**

Keep hands, hair, loose clothing, and tools away from moving parts such as fans, belts, wire drive rolls, and rotors. Keep all doors, panels, and guards closed and secured.

### 3. Plasma Arc Cutting Hazards

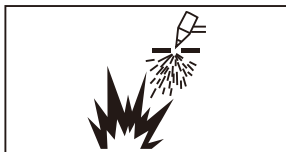

**Cutting sparks can cause fire or explosion.**



Do not cut near flammable material or where the atmosphere can contain flammable dust, gas, or liquid vapors (such as gasoline). Move flammables at least 35 feet (11 meters) away or protect them with flame-proof covers (see NFPA 51B listed in Section 9).

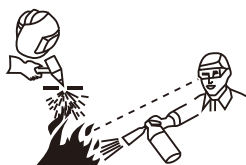

Cutting sparks can cause fires. Have a fire extinguisher nearby, and have a trained fire watch ready to use it. After completion of work, inspect area to ensure it is free of sparks, glowing embers, and flames.



Do not cut on containers that have held combustibles, or on closed containers such as tanks, drums, or pipes unless they are properly prepared according to AWS F4.1 and AWS A6.0 (see Safety Standards in Section 9).



**Plasma arc can injure.**

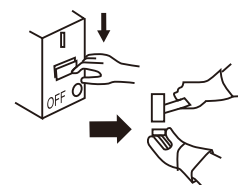

Turn off power before disassembling torch.

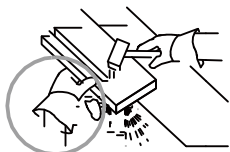

Do not grip material near cutting path.  
Do not touch hot parts bare-handed.



## Electric shock from torch or wiring can kill.

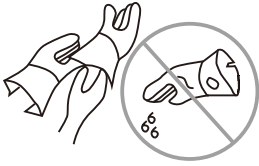

Wear dry insulating gloves. Do not wear wet or damaged gloves. Do not touch live electrical parts.

Do not use worn, damaged, undersized, or repaired cables.

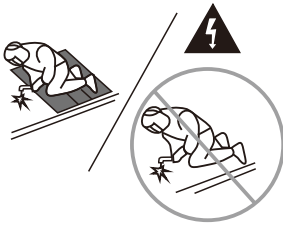

Protect yourself from electric shock by insulating yourself from work and ground. Use non-flammable, dry insulating material if possible, or use dry rubber mats, dry wood or plywood, or other dry insulating material big enough to cover your full area of contact with the work or ground. Watch for fire, smoke, and sparks.

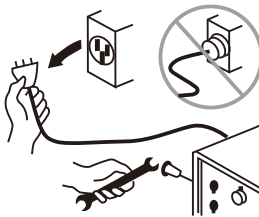

Disconnect input plug or power before working on machine. Do not make input connections if color blind.

Frequently inspect input power cord and ground conductor for damage or bare wiring – replace immediately if damaged – bare wiring can kill. Keep cords dry, free of oil and grease, and protected from hot metal and sparks. Be sure input ground wire is properly connected to a ground terminal in disconnect box or receptacle.

Properly install, ground, and operate this equipment according to its Owner's Manual and national, state, and local codes.



## Breathing cutting fumes can be hazardous to your health.



Keep your head out of the fumes. Do not breathe the fumes. Use enough ventilation, exhaust at the arc, or both, to keep fumes and gases from your breathing zone and the general area. The recommended way to determine adequate ventilation is to sample for the composition and quantity of fumes and gases to which personnel are exposed.

Read and understand the Safety Data Sheets (SDSs) and the manufacturer's instructions for adhesives, coatings, cleaners, consumables, coolants, degreasers, fluxes, and metals.

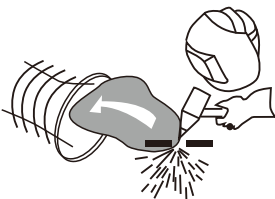

Use enough forced ventilation or local exhaust (forced suction) at the arc to remove the fumes from your breathing area.

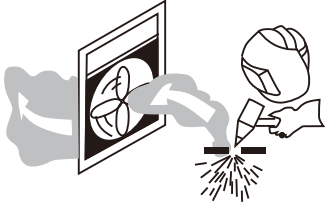

Use a ventilating fan to remove fumes from the breathing zone and cutting area. If adequacy of ventilation or exhaust is uncertain, have your exposure measured and compared to the Threshold Limit Values (TLV) in the Safety Data Sheet (SDS).



**Arc rays can burn eyes and skin.**

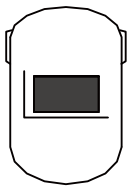

Use welding helmet or face shield with correct shade of filter (see Section to choose the correct shade).



Wear welders cap and safety glasses with side shields. Use ear protection when cutting out of position or in confined spaces. Button shirt collar.

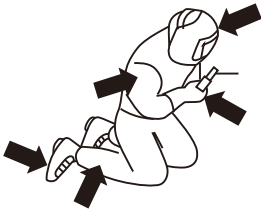

Wear body protection made from durable, flame-resistant material (leather, heavy cotton, wool). Body protection includes oil-free clothing such as leather gloves, heavy shirt, cuffless trousers, high shoes, and a cap.

Periodically double-check all nuts and bolts for tightness and condition

**Loose or incorrect hardware and fasteners can injure, and damage equipment.**

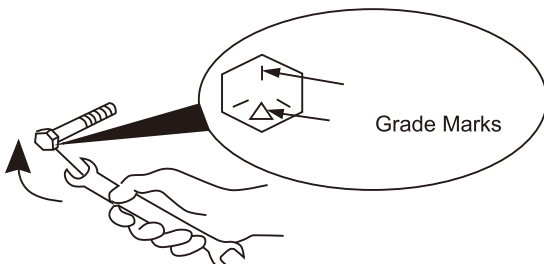

If necessary, always replace any fastener with one of equal size, grade, and type. Be sure the grade marks on replacement fastener match the original bolt. The manufacturer's identification mark .

## 4. Special Situations & Equipment



### **Confined spaces can be hazardous.**

Confined spaces are areas which lack room for full movement and often lack ventilation, such as storage tanks, vats, tunnels, boilers, pipes, hold of a ship, corners of a room, near a ceiling or floor corner, or in a pit. Gases can collect and form dangerous concentrations.

Always open all covers, remove any hazardous or toxic materials, provide forced ventilation, and provide a means to turn off power and gas from the inside.

Never work alone — have constant communication with someone outside who can quickly turn off power and gas, is trained in rescue procedures, and is able to pull you out in case of emergency.

Do not use AC weld output in confined spaces.

Insulate yourself from work and ground using non-flammable, dry insulating material if possible, or use dry rubber mats, dry wood or plywood, or other dry insulating material big enough to cover your full area of contact with the work or ground, and watch for fire.

Always check and monitor the air quality in the space. Welding or cutting fumes and gases can displace air and lower the oxygen level — use ventilation and, if needed, an air-supplied respirator. Be sure the breathing air is safe. The recommended way to determine adequate ventilation is to sample for the composition and quantity of fumes and gases.

Always remember: All normal arc welding and cutting hazards are amplified in confined spaces. See ANSI Z49.1 listed in Principal Safety Standards (Section 9).



### **Cylinders can explode if damaged.**

Confined spaces are areas which lack room for full movement and often lack ventilation, such as storage tanks, vats, tunnels, boilers, pipes, hold of a ship, corners of a room, near a ceiling or floor corner, or in a pit. Gases can collect and form dangerous concentrations.

Always open all covers, remove any hazardous or toxic materials, provide forced ventilation, and provide a means to turn off power and gas from the inside.

Never work alone — have constant communication with someone outside who can quickly turn off power and gas, is trained in rescue procedures, and is able to pull you out in case of emergency.

Do not use AC weld output in confined spaces.

Insulate yourself from work and ground using non-flammable, dry insulating material if possible, or use dry rubber mats, dry wood or plywood, or other dry insulating material big enough to cover your full area of contact with the work or ground, and watch for fire.

Always check and monitor the air quality in the space. Welding or cutting fumes and gases can displace air and lower the oxygen level — use ventilation and, if needed, an air-supplied respirator. Be sure the breathing air is safe. The recommended way to determine adequate ventilation is to sample for the composition and quantity of fumes and gases.

Always remember: All normal arc welding and cutting hazards are amplified in confined spaces. See ANSI Z49.1 listed in Principal Safety Standards (Section 9).

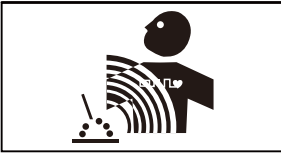

### **Electric and magnetic fields (EMF) can affect Implanted Medical Devices.**

Wearers of Pacemakers and other Implanted Medical Devices should keep away. Implanted Medical Device wearers should consult their doctor and the device manufacturer before going near arc welding, spot welding, gouging, plasma arc cutting, or induction heating operations.



### **Hot parts can burn.**

Do not touch hot welded or cut parts with bare hand. If handling is needed, use proper tools and/or wear heavy, insulated welding gloves to prevent burns. Allow cooling period before handling parts or working on equipment.



### **Falling equipment can injure, and damage equipment.**

Use lifting eye to lift unit only, NOT running gear, gas cylinders, trailer, or any other accessories. Use correct procedures and equipment of adequate capacity to lift and support unit. If using lift forks to move unit, be sure forks are long enough to extend beyond opposite side of unit. Do not place unit where it can easily tip over or fall.

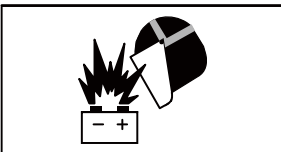

### **Battery charging output and battery explosion can injure.**

Sparks can cause battery gases to explode. Do not smoke and keep matches and flames away from battery. Wear a face shield or safety glasses when working near or on a battery. Do not use welder or plasma cutter to charge batteries or jump start vehicles unless the unit has a battery charging feature designed for this purpose.

## **5. EMF Information**

Electric current flowing through any conductor causes localized electric and magnetic fields (EMF). The current from arc welding (and allied processes including spot welding, gouging, plasma arc cutting, and induction heating operations) creates an EMF field around the welding circuit. EMF fields can interfere with some medical implants, e.g. pacemakers. Protective

measures for persons wearing medical implants have to be taken. For example, restrict access for passers-by or conduct individual risk assessment for welders. All welders should use the following procedures in order to minimize exposure to EMF fields from the welding circuit:

1. Keep cables close together by twisting or taping them or using a cable cover.
2. Do not place your body between welding cables. Arrange cables to one side and away from the operator.
3. Do not coil or drape cables around your body.
4. Keep head and trunk as far away from the equipment in the welding circuit as possible.
5. Connect work clamp to workpiece as close to the weld as possible.
6. Do not work next to, sit or lean on the welding power source.
7. Do not weld whilst carrying the welding power source or wire feeder.

About Implanted Medical Devices:

Implanted Medical Device wearers should consult their doctor and the device manufacturer before performing or going near arc welding, spot welding, gouging, plasma arc cutting, or induction heating operations. If cleared by your doctor, then following the above procedures is recommended.

## 6. California Proposition 65 Warnings



**WARNING:** The machine is mainly used for industrial purpose. It will cause radio interference indoor, operators shall take fully preventative measures.

For more information, go to [www.P65Warnings.ca.gov](http://www.P65Warnings.ca.gov).



**WARNING:** Cancer and Reproductive Harm – [www.P65Warnings.ca.gov](http://www.P65Warnings.ca.gov).

For Diesel Engines:



**WARNING:** Breathing diesel engine exhaust exposes you to chemicals known to the state of California to cause cancer and birth defects or other reproductive harm.

- Always start and operate the engine in a well-ventilated area.
- If in an enclosed area, vent the exhaust to the outside.
- Do not modify or tamper with the exhaust system.
- Do not idle the engine except as necessary.

For more information, go to [www.P65Warnings.ca.gov](http://www.P65Warnings.ca.gov).

## 7. Principal Safety Standards

Safety in Welding, Cutting, and Allied Processes, American Welding Society standard ANSI Standard Z49.1. Website: [www.aws.org](http://www.aws.org).

Safe Practices for the Preparation of Containers and Piping for Welding and Cutting, American Welding Society Standard AWS F4.1 from Global Engineering Documents.

Website: [www.global.ihs.com](http://www.global.ihs.com).

Safe Practices for Welding and Cutting Containers that have Held Combustibles, American Welding Society Standard AWS A6.0 from Global Engineering Documents.

Website: [www.global.ihs.com](http://www.global.ihs.com).

National Electrical Code, NFPA Standard 70 from National Fire Protection Association. Website: [www.nfpa.org](http://www.nfpa.org) and [www.sparky.org](http://www.sparky.org).

Safe Handling of Compressed Gases in Cylinders, CGA Pamphlet P-1, from Compressed Gas Association. Website: [www.cganet.com](http://www.cganet.com)



## 8. Lens Shade Selector Guide

Operation/Process	Electrode Size in. (mm)	Arc Current (Amperes)	Minimum Protective Shade	Suggested* Shade No. (Comfort)
Shielded metal arc welding (SMAW)	Less than 3/32 (2.5)	Less than 60	7	—
	3/32–5/32 (2.5–4)	60–160	8	10
	5/32–1/4 (4–6.4)	160–250	10	12
	More than 1/4 (6.4)	250–550	11	14
Gas metal arc welding (GMAW) and flux cored arc welding (FCAW)		Less than 60	7	—
		60–160	10	11
		160–250	10	12
		250–550	10	14
Gas tungsten arc welding (GTAW)		Less than 50	8	10
		50–150	8	12
		150–500	10	14
Air carbon arc cutting (CAC–A)	(Light)	Less than 500	10	12
	(Heavy)	500–1000	11	14
Plasma arc welding (PAW)		Less than 20	6	6 to 8
		20–100	8	10
		100–400	10	12
		400–800	11	14
Plasma arc cutting (PAC)		Less than 20	4	4
		20–40	5	5
		40–60	6	6
		60–80	8	8
		80–300	8	9
		300–400	9	12
		400–800	10	14
Torch brazing (TB)		—	—	3 or 4
Torch soldering (TS)		—	—	2
Carbon arc welding (CAW)		—	—	14
	Plate thickness			
	in.	Mm		
Oxyfuel gas welding (OFW)	Light	Under 1/8	Under 3.2	4 or 5
	Medium	1/8 to 1/2	3.2 to 12.7	5 or 6
	Heavy	Over 1/2	Over 12.7	6 or 8
Oxygen Cutting (OC)	Light	Under 1	Under 25	3 or 4
	Medium	1 to 6	25 to 150	4 or 5
	Heavy	Over 6	Over 150	5 or 6

As a rule of thumb, start with a shade that is too dark to see the weld or cut zone. Then go to a lighter shade which gives sufficient view of the weld or cut zone without going below the minimum. In oxyfuel gas welding, cutting, or brazing where the torch produces a high yellow light, it is desirable to use a filter lens that absorbs the yellow or sodium line in the visible light of the (spectrum) operation.

Guide adapted from ANSI Z49.1, 2012.

# PRODUCT DESCRIPTION

---

This welding machine is equipped with the world's most advanced inverter technology.

The inverter's working principle is that the 60Hz power line frequency is transformed to direct current and inverted to a high frequency using a high power IGBT device. After that, a voltage drop is generated and it is transformed to a to high-current DC using the Pulse Width Modulation (PWM) technology. Using the power inverter technology, the volume and the weight is substantially reduced and the conversion efficiency is increased by 30%.

The MIG155GD is a self-shielding welding machine that can be used for MIG as well as for flux-cored arc welding. It is equipped with a unique electrical reactor, which can precisely control the short-circuit transfer and mixed transfer modes, this way it shows better performance than other machines. Compared with welding machines using silicone controlled rectifier and hot tapping, our products have the following advantages: stable wire feed rate, portable, energy saving, free of electromagnetic noise. Besides, our products spatter less, easier arc starting, deep welding pool, high duty cycle, etc.

This machine features a design which has the following advantages: high efficiency, power saving, etc. It is especially suitable for private users who wish to work with different metals using different techniques.

Thank you for choosing our product. Please feel free to share your valuable suggestions with us; we are continuously working on improving our products and services.



## **WARNING**

**The machine is mainly used for industrial purposes. It causes radio interference when used indoor. Users must take preventative measures.**

# THREE YEARS WARRANTY

WELDPRO Warranty and Return Terms  
Welders and Plasma Cutters

All Weldpro welders and plasma cutters are covered under the following specific terms of warranty. All welders and plasma cutters are warranted to the original purchaser only, when purchased through an authorized seller of Weldpro products for a period of three (3) years from the date of purchase, to be free of manufacturers defect or failure. Proof of purchase and date of purchase paperwork will be required by Weldpro at the time of the claim.

Extended warranty coverage may be available for Weldpro welders and plasma cutters at an additional cost. Always check with Weldpro.

The Weldpro warranty is limited to defects, malfunctions or failure of the equipment to operate properly based specifically and solely from manufacturer defects. Any malfunctions from improper use, lack of maintenance, incorrect or insufficient source supply power to the units, shipping damage, and similar failures not related to specific manufacturers defect will not be honored.

Weldpro will not be responsible in the event of a product failure, for lost time in operation or use of said product. Rather it will honor solely the product itself only.

Further, the warranty will cover the repair or replacement of the unit in question for the term of the warranty with either a new or a refurbished unit, or in some cases replacement parts of the same model, at the discretion of Weldpro. As a term of the Weldpro warranty, if and when applicable, individual parts are needed, they may be supplied to the customer rather than replacing the entire unit. Situations like this may include, but are not limited to items such as foot pedals, torches, mig wire rollers, feed spools, or any other item Weldpro deems more practical to supply individually.

Weldpro will provide free shipping return of the damaged product due to manufacturers defect for the first 30 days of the warranty term if shipping is within the lower 48 United States. Customers outside this area must check with Weldpro for further shipping instructions. Failures after the initial 30-day period, and due to manufacturers defect, may not enjoy free return shipping.

If it is determined when the product is returned to Weldpro that there is no malfunction, or that the assumed malfunction by the customer was user error, Weldpro may request a shipping fee refund prior to the return of the item to the customer.

Prior to returning any item thought to be malfunctioning or damaged due to manufacturers defect, customers are required to contact Weldpro first, to explain the failure and to obtain a Return Merchandise Authorization number, or the item may not be covered under the terms of this warranty.

Weldpro ships in the USA from third party shippers such as, but not limited to UPS, FedEx, and the USPS. Weldpro is not responsible for damage that occurs during shipping. It is the customer's responsibility to check the item at the time of delivery. If a customer receives an item damaged, they must immediately contact both Weldpro and the shipper to document and report the damage as soon as possible, and in no circumstances later than 48 hours after delivery. All shipping and delivery dates are tracked for arrival. Weldpro may require photo image of the damage at their discretion.

Returned items within the first 30 days. Undamaged items in good working condition may be returned within the first 30 days of purchase. In such a case, these items are not eligible for the free return shipping policy associated with items that have manufacturers defects. A restocking fee will be charged for said return of up to 25% on any item returned with a valid RMA number that are undamaged and not covered or subject under the terms of this warranty. The amount of the restocking fee is solely at the discretion of Weldpro and based on the condition of the returned item and its accessory parts and packaging. Further, should Weldpro receive an item in good working condition that has sustained physical damage, Weldpro has the right to refuse acceptance of said returned item completely, and the customer will be responsible for return shipping of the product to them.

Weldpro does not imply or suggest any interpretation of the above warranty beyond what is stated in this print of its terms.

Weldpro is not responsible for injury due to improper use of the equipment or failure to heed all of the safety precautions associated with the dangers of welding or cutting metals.

The terms and conditions of the Weldpro warranty are subject to change without notice. Be sure to check the terms of the Weldpro warranty prior to your purchase.

# TECHNICAL PARAMETERS

Model Parameters	MIG155GD			
Supply voltage (V)	1 phase 115V±15%	1 phase 230V±15%		
Frequency (Hz)	50/60			
Rated input current (A)	MIG: 35.7 MMA: 40	MIG: 25.4 MMA: 26.7		
No-load voltage (V)	59			
Output current (A)	MIG: 30-120 MMA: 30-110	MIG: 30-155 MMA: 30-140		
Output voltage (V)	MIG: 15.5-20 MMA: 21.2-24.4	MIG: 15.5-22 MMA: 21.2-25.6		
Duty cycle (%)	MIG: 30%120A 100%80A	MMA: 30%110A 100%80A	MIG: 30%155A 100%100A	MMA: 30%140A 100%100A
Power factor	≥0.73			
Efficiency (%)	≥80			
Wire speed (ft/min)	6.6-32.8			
Post flow (s)	1			
Wire diameter (in)	MIG: .023-.030 Flux-cored: 0.30-0.40			
Appropriate thickness	22ga.-8ga.			
Housing protection class	Ip21			
Insulation class	F			
Cooling method	Fan-cooled			
Weight (lb)	35.7			
Dimensions (in)	15.3x6.6x13.1			

# GENERAL WELDING FACTS

---

Unlike soldering or brazing, welding is the process of fusing two pieces of metal together to create a permanent union. In order to do so, there are many different types of welding. Most all the popular methods of welding require the weld area to be protected in one way or another from the atmosphere around the weld while the weld is being performed. This is done by various means in order to prevent contamination of the weld, which would result in a very poor quality product that lacked not only appearance, but fusion. The weld would be full of porosity, and would be too weak to be effective in joining the work metals. Shielding the weld area during welding is very important to a good weld.

Three of the most popular types of welding are offered with the MIG155GD. They will be briefly described here.

The MIG155GD is capable of performing MIG welding, Flux Core welding, and MMA welding.

MIG welding refers to “Metal Inert Gas” welding, a process where solid metal wire is continuously fed through a torch cable while being shielded from the contamination of the atmosphere around the weld by a special shielding gas. Typically for MIG welding that shielding gas is a mix of Carbon Dioxide (CO<sub>2</sub>) and Argon gas, usually in the percentage of 25% CO<sub>2</sub> and 75% Argon. It is the cleanest, smoke free of the three weld types.

Flux Core welding, while very similar to MIG welding does not require any shielding gas to be added to the process. This is because Flux Core welding by definition uses a hollow wire, like a miniature straw and inside the wire, in its core, is a flux which creates it's own gas that provides the shielding as it is heated in the weld. The heat of the welding process turns the flux into a gas that envelops the weld area, shielding it from the atmosphere.

MMA welding, (the third type) refers to Manual Metal Arc welding. This process is known by many other slang names such as “stick welding” or “arc welding”. This type welding is performed by placing a welding rod, or stick. into its holder and scratching its end to the metal to be welded which starts the electric arc. This type welding is also shielded from the atmosphere with a flux that is heated into a gas that surrounds the area being welded. This time however, the flux is coated on the outside of the consumable welding rod and no shielding gas tank is needed.

You can learn much more about each type welding as well as many others by simply searching the Internet.

# ELECTRICAL VOLTAGE

---

Three additional considerations that need to be addressed and understood, with each type welding that your new MIG155GD is capable of producing are voltage, amperage and most importantly, Electrical Polarity.

Think of voltage as the electrical equivalent of water pressure, and amperage as the electrical equivalent of the flow rate of that water. With electricity, the more amperage the more heat and the more voltage, the more it pushes that heat through the electrical circuit.

There are basically two types of electric current. AC (alternating current) and DC (direct current). Direct current travels around its circuit in only one direction, while alternating current switches its direction back and forth in the circuit, in the USA, 60 times per second, or 60hz.

Your new MIG155GD is a DC (direct current welder) which means the current or (amperage) travels only in one direction. However, you have the ability to manually change that direction as needed for the choice of three welding types available with the MIG155GD.

You can choose from either “electrode positive” or “electrode negative”. Current in an electrical circuit travels from negative (or minus) to positive (or plus). Your electrode, is your torch gun, and your ground or work cable is what is attached to the metal being welded. You can choose to direct the current in the circuit toward or away from your welding torch end (electrode) as it travels in its circuit.

When welding using either the MIG style or MMA style of welding we want our polarity to be “electrode positive”. With current always traveling from negative to positive, (minus to plus). Doing so forces the current to travel toward our torch end which creates more heat at the consumable welding material being used in our torch, which produces a smoother better penetrating, more evenly melting weld.

When choosing Flux Core welding however, with the thinner more delicate flux core wire, we choose “electrode negative”. This changes the direction of the current helping to prevent the flux core wire from prematurely melting off from overheating by directing the current flow toward the work (or ground) and away from our electrode.

A little tidbit of information that might help prevent confusion. The direction of polarity is also sometimes referred to as DCEN or DCEP. Direct Current, Electrode Negative or, Direct Current Electrode Positive. And to further complicate their names, in addition, they also refer to the polarity as either Straight Polarity or Reverse Polarity, with electrode negative being straight polarity and electrode positive being reverse polarity.

Many welders in the USA have a funny way of remembering all this by oddly enough using two names of government officials. SENators and REPresentatives. Just remember SENator as Straight polarity Electrode Negative, and REPresentative as Reverse polarity Electrode Positive. Hope that little secret helps you remember!

# INSTALLATION

Before connecting the machine, ensure that the power supply is cut off. The welding machine is equipped with an input voltage compensation device. This device allows the machine to work without interruption when the input voltage fluctuates  $\pm 10\%$  with respect to the nominal voltage. When using a long cable in order to reduce the voltage drop, a cable with big cross section area is suggested. If the cable is too long, this will affect the arc starting performance and other system functions, we suggest to use the recommended length.

The MIG155GD can be used for both MIG (which is solid wire with shielding gas) and flux-cored arc welding. Please see below the MIG welding installation diagram. In flux-cored arc welding mode the gas cylinder does not need to be connected, however the polarity must be reversed.

- **Changing Polarity**

The short dangle wire on the front of the machine will determine the polarity of your MIG welding or flux core welding. When flux core welding plug the short dangle wire into the minus (-) connector on the left side as you face the machine. When you are MIG welding with gas, plug that dangle lead into the (+) connector, and of course the ground clamp goes into the remaining connector.

- **Installation diagram in Mig mode**

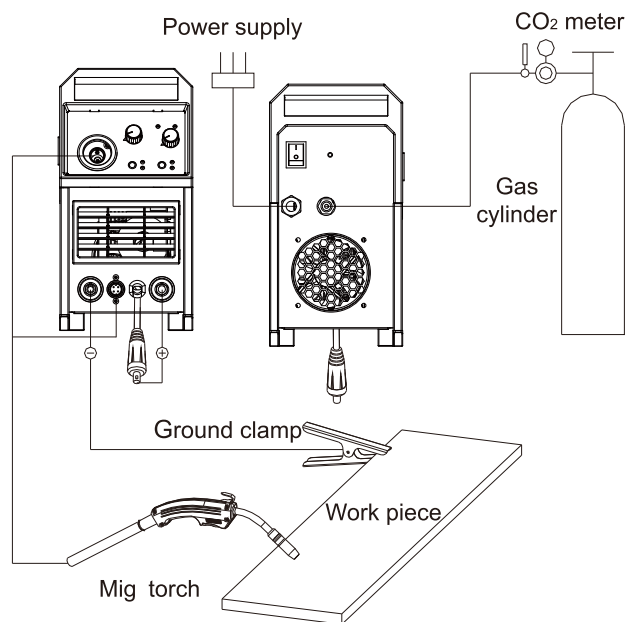

- **Installation diagram in MMA mode**

(AKA, Arc welding, Stick welding.) Switch over the front panel toggle to the MMA position. No gas is needed. Connect torch to “plus” and ground to “minus” to run your MMA in “reverse polarity, electrode positive. DCEP

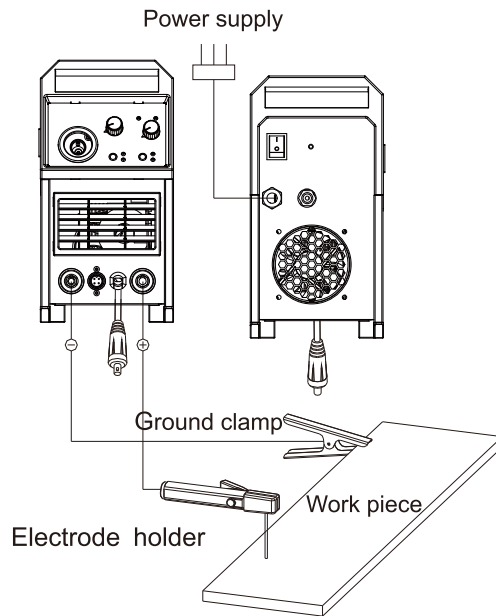

**FLUX CORE WELDING .**

Follow the above procedure, except shielding gas is not required nor does it have to be connected to your welder. Remember to change the polarity on your welding lead so that the ground clamp is connected to the “plus” dinse connector on your welder and the polarity lead which is located in the center, between the plus and minus dinse connectors, is connected to the “minus” plug. DCEN



- **Installation of nozzles and contact tips**



Thread off your nozzle. Under that nozzle will be the contact tip, be sure to unscrew that and remove it before you feed your new wire in. Once the new wire has been fed through slide the contact tip back over the wire and gently thread it back on, being sure not to over tighten it.

While you have the contact tip off it's a good idea to look at the size marked on the contact tip. There are times when it will be marked with Imperial measurements such as .023, .030, or .035 thousandths. You may find other markings designated in metric sizes such as 0.6, 0.8 or 0.9 which match the previously listed Imperial measurements respectively. Be sure the contact tip diameter orifice matches the wire that you've selected.

- **Installation of MIG torch**

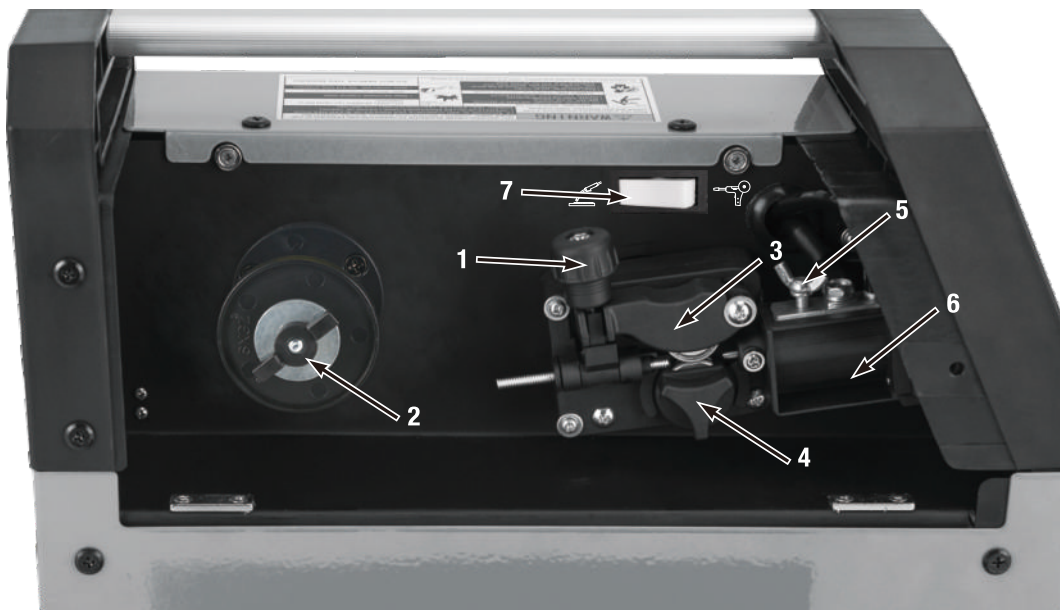

**Figure 2**

Connecting the torch cable is a relatively simple straightforward operation with only a few things to keep in mind. The first is, inside the cavity where your reel of wire is stored and your drive motor mechanism is located, slightly to the right of your drive roller mechanism as you look at it, you will see the brass housing (FIG2.6) that your torch cable will slide into. Just above that brass connector, you will notice a silver thumb screw (FIG2.5). Be sure to back that thumb screw out far enough so that it won't interfere with the installation of your torch cable. Once that thumb screw is backed out, very slightly moisten the two O-rings on the torch cable and slide it in to the front of the machine firmly until it completely seats. Once you have it seated completely you can turn the silver thumb screw to gently snug against your torch cable.

**Note :** failure to back this torch cable thumb screw out before you install your torch cable into the machine may result in your C25 gas leaking, since your o-rings will not properly seat deep enough into the brass housing.

- **Installation of welding wire**

Installing a new roll of wire for the first time may be a bit confusing and even complicated. One of the biggest concerns to keep in mind is that if you don't keep control over that rolled up wire it will spring open and you'll find yourself with a mess all over the floor. The 155 amp model MIG welder can accept 1.98lb reel of wire.

1. Release the wire tensioner on your drive motor mechanism. Tilt down the roller tensioner (FIG2.1) toward you, then lift and flip the tensioner assembly (FIG2.3) up.



2. Twist the drive roller knob (FIG2.4) counter clockwise to remove it. Slide out the lower drive roller.

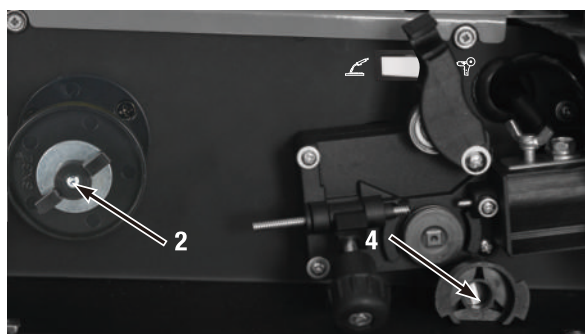

\*Tips about drive rollers: You'll see two different rollers provided. One will be on the machine and the other will be in a bag. If you look very closely at the grooves, one has teeth and one does not. The one with the teeth is called the knurled drive roller (FIG3) and is designed to be used with your flux core wire. The smooth drive roller is for solid core MIG wire(FIG4). The drive roller will have markings on the front and back in two different sizes, in either millimeters or thousandths. A .06mm will handle 0.023 to 0.025 wire. Likewise a .08 will handle .030 wire. Be sure the correct size groove is in the outer position of the drive assembly to match the size of the wire you will be using and reinstall. Do not over tighten the wire tensioner on the drive mechanism.

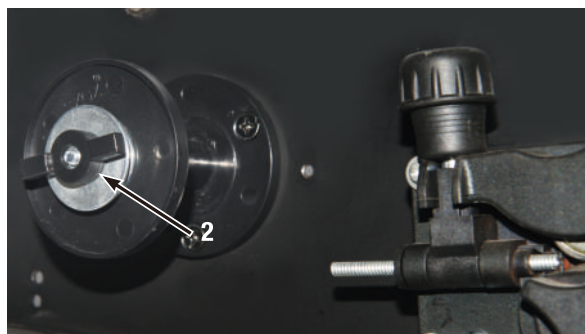

**Figure 3** example of knurled drive roller



**Figure 4** example of smooth drive roller

3. Remove the spool retainer (2) by turning it counter clockwise.



4. Remove any plastic covering that may be on your new wire but do not un-secure the wire that is in the spool yet unless it interferes with the following test. If it does, just secure the loose wire end with painters tape or similar to the rest of the wire temporarily.
5. Place your wire spool on the idler roller with the wire set up to be fed from the bottom as seen in the photo. Before un-securing the wire, replace the spool retainer and spring. Next roll the wire spool to be sure it turns freely with just a slight drag.



**Note:** a slight drag is necessary and should be provided correctly by the spool retainer spring. The drag will prevent the wire from continuing to spin and unwind itself each time you release your torch trigger. Should the drag be too tight, you may have to remove the sticker from your wire spool to provide more movement room.

6. Continue feeding the wire through the drive roller mechanism and into the torch cable orifice approximately 6 inches. Once you've done that you can clamp your drive roller tensioner back down on the lower drive roller being sure that you don't apply too much tension to the welding wire. You are much better off starting with a lighter tension and should your cable slip as it feeds you can always gently tighten your tensioner. You are now ready to automatically feed your new reel of welding wire through your torch cable.



7. The W Weldpro MIG machines have a special function that auto senses welding current. When you pull the trigger wire will feed slowly for 4 seconds, if the machine does not sense any welding current, it will speed up to full speed, that will help you feed your new roll of wire. Try to keep the MIG cable as straight as possible while you feed new wire.

**Note:** never attempt to adjust your wire speed for welding by holding your Mig cable out into the air, you will only invoke the automatic high-speed welding wire feed system.

8. Once your wire has been fed through your torch cable you can reinstall your contact tip by sliding it over the end of the newly installed wire and then snug it securely without over tightening it. Remember these are brass fittings and they are delicate.

## SET UP FOR SPOOL GUN WELDING

The WELDPRO MIG155GD is set up to use a spool gun which allows for easy feeding of aluminum wire to expand your welding capabilities. This is an optional accessory and can be purchased separately from WELDPRO.



### **WARNING**

#### **DANGER ELECTRIC SHOCK HAZARD!**

Turn welder off and unplug from power source before installing or removing Spool Gun.

1. Switch the selector switch to the Spool Gun position.
2. Open the side door of the welder and loosen the Torch Tensioner located on the side of the drive roller. If the standard welding gun is installed remove it and its associated connector.
3. Slide the brass body of the Spool Gun in through the front of the unit in the designated hole. Be sure to insert until it bottoms against the drive assembly or a gas leak may occur.
4. Connect the metal plug to the gun trigger connection on the front of the welder.
5. Tighten the Torch Tensioner finger tight.

## SET UP FOR SPOOL GUN WELDING



### **DANGER**

#### **ELECTRIC SHOCK HAZARD!**

Turn welder off and unplug from electrical outlet.



### **WARNING**

#### **WELDING WIRE CAN BE DANGEROUS!**

1. Never point the welding gun at any part of the body, other people, or metal surfaces.
2. Wear safety glasses and handle welding wire safety as it can be sharp and cause injury.

1. Set the switch above the drive motor to the spool gun setting (Figure2.7).
2. Remove the thumb screw and clear plastic wire spool cover.
3. Remove the thumb screw and spring tensioner that holds the wire spool on (FIG. J1).
4. Place wire spool on spindle and replace the thumb screw with spring tensioner and tighten till the point that the spool has some tension on it.
5. Loosen the Brass Tensioner Thumb Screw (FIG. J2) until it is possible to feed the welding wire through the drive roller grooves.
6. Feed the wire by hand from the spool into the inlet guide, (FIG. J3) past the drive rollers and into the wire inlet (FIG. J4).
7. Tighten the Brass Tensioner Thumb Screw (FIG. J2) until it applies light pressure onto the welding wire. If this is too tight it will deform the wire and cause feeding issues, if it is too loose the drive roller will slip on the wire.
8. Remove the nozzle and contact tip.

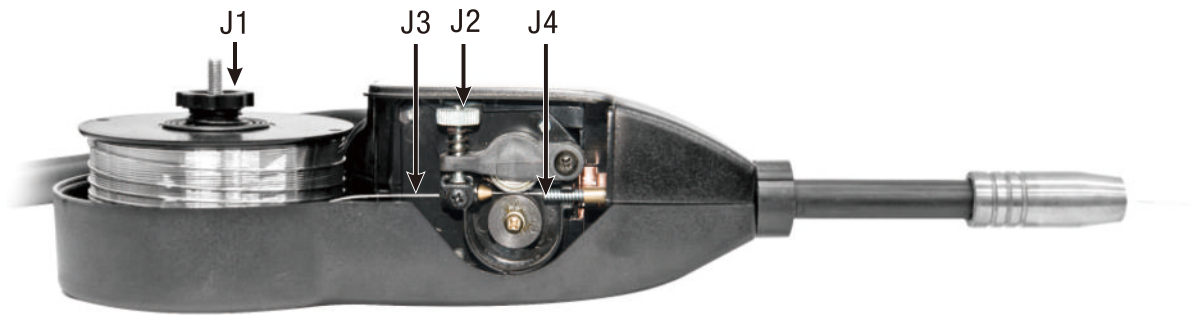

1. Replace the wire spool cover.
2. Plug in welder to your power source and turn on the welder.
3. Trigger the Spool Gun to feed the wire and adjust the Brass Tensioner Thumb Screw (FIG. J2) so that the wire does not slip.
4. Replace Contact Tip and Nozzle.
5. Feed wire through the gun and cut the wire exposing a ~1/4" length out of the contact tip.

**\*\*\*Please remember also if you are unsure of any connection or any process, at anytime if you have any questions, please contact technical support at 651 329 2686 we are available 7 days a week from 9 a.m. to 9 p.m. eastern time.**

# OPERATION

## 1 Front panel layout

The values of the adjustment knob are indicated on the front panel of the machine. The pictures in this manual are for reference only. The actual product may be different.

- **Front panel**

1	Voltage adjustment knob
2	Power indicator light
3	Fault indicator
4	Current adjustment knob
5	MIG welding torch
6	Negative outlet
7	Polarity Reversing Switch
8	Positive outlet
9	2T/4T control switch
10	MMA/MIG control switch
11	4 pin aviation plug

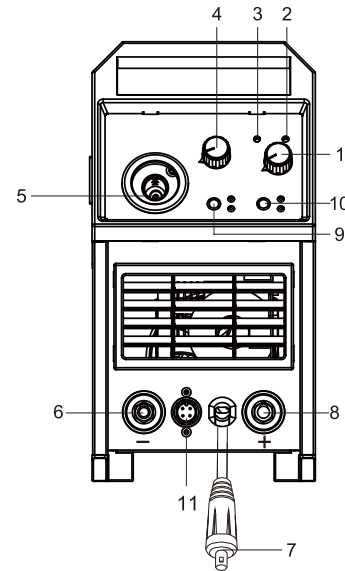

- **Back panel**

12	Power switch
13	Power supply outlet
14	Gas cylinder inlet connector

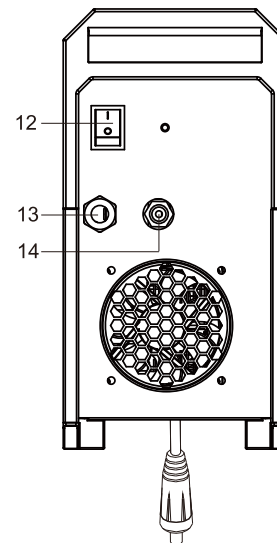

## 2 Operating instructions

- Turn on the power switch, the power indicator light comes up and the fan starts running.
- Set the welding current according to the requirements of the welding work.
- Usually, the necessary welding current for the electrode welding is as follows:

Wire Type	Shielding Gas (20-30)CFR Flow Rate	Wire Diameter	24ga	22ga	20ga	17ga	14ga	1/8"	5/36"	1/16"	1/4"
			(0.61mm) V/A	(0.8mm) V/A	(1.0mm) V/A	(1.5mm) V/A	(2.0mm) V/A	(3.0mm) V/A	(4.0mm) V/A	(5.0mm) V/A	(6.0mm) V/A
MIG solid wire	75%Ar 25%CO <sub>2</sub>	0.6/.024"	15.0/40	15.7/50	16.5/65	18.5/90	20/115	20.7/130	-	-	-
		0.8/.030"	-	16.0/50	16.5/65	17.5/80	19/110	20.5/140	22/160	-	-
		0.9/.035"	-	-	17.0/65	18.0/85	19.5/105	21/145	22.5/170	23.5/200	25/220
	100%CO <sub>2</sub>	0.6/.024"	15.6/40	16.5/50	17.3/65	19.2/100	21.5/115	21.6/130	-	-	-
		0.8/.030"	-	16.5/50	17.0/65	18.0/80	20.5/110	21.5/140	23/160	-	-
		0.9/.035"	-	-	17.5/65	18.5/85	20/105	21.5/145	23.5/170	24.5/200	26/220
Flux-cored	-	0.8/.030"	-	-	15.5/65	16.5/70	19/100	21.5/130	-	-	-
		0.9/.035"	-	-	-	16.5/70	19/100	22/135	23.5/165	24.5/200	-

Material	Electrode Type	Wire Diameter	17ga	14ga	1/8"	5/36"	1/16"	1/4"	≥ 1/4"		
			Amps.	Amps.	Amps.	Amps.	Amps.	Amps.	Amps.	Amps.	Amps.
MMA Stainless steel, steel	Acid electrode	2.5	30	50	70	90	-	-	-	-	-
		3.2	-	50	70	90	140	-	-	-	-
		4	-	-	70	90	140	200	-	-	-
	Cellulose electrode	2.5	-	65	80	100	-	-	-	-	-
		3.2	-	-	80	100	130	150	-	-	-



# DAILY CHECKING

WELDING TORCH		
Component	To check	Remarks
Air vent	Check if the torch is properly connected and if there are any deformations.	There may be an air leak
	Check if it produces splatter.	The welding torch might burn out (use spatter resistant materials)
Electric outlet	Check if the torch is properly connected.	The screw thread of the welding torch may be damaged.
	Check if the head is damaged and if the orifice of the outlet is blocked.	May cause unstable arc or block arc starting.
Wire supply tube	Check the size of the tube extension piece.	The tube must be at least .230". If the extension piece is too small, the arc is unstable.
	Check if the diameter of the wire matches the inner diameter of the tube.	May cause unstable arc. Use an adequate tube.
	Check the reel and the extension piece.	May result in poor wire supply and unstable arc. Change the tube.
	Check for blockage caused by dirt or wire residue.	May result in poor wire supply and unstable arc (clean the tube with kerosene or change it)
	Check if the wire supply tube is damaged or the O-ring is worn down.	1. The tube was damaged by the heat. Change it. 2. Change the O-ring.
CABLES		
Component	To check	Remarks
Cable of the welding torch	<ul style="list-style-type: none"> <li>• Check if the cable of the welding torch is bent too much.</li> <li>• Check if the mobile connector is well connected.</li> </ul>	<ol style="list-style-type: none"> <li>1. May cause poor wire supply.</li> <li>2. If the cable is bended too much, the arc will be unstable</li> </ol>
Output cable	<ul style="list-style-type: none"> <li>• The insulation is worn down.</li> <li>• The cable connector is naked (damaged insulation) or loose (primary point between the power supply and the cable)</li> </ul>	<p>For your safety and to ensure a stable welding, select the appropriate method to carry out the inspection, according to the workplace.</p> <ul style="list-style-type: none"> <li>• Standard daily inspection.</li> <li>• Thorough and deep inspection in set intervals.</li> </ul>
Input cable	<ul style="list-style-type: none"> <li>• Check if the power supply connector and the protective equipment are connected properly.</li> <li>• Check if the safety equipment is connected properly.</li> <li>• Check if the connector of the input cable is connected properly.</li> <li>• Ensure that the input cable is not worn down and that the conductor is not exposed.</li> </ul>	
Grounding cable	<ul style="list-style-type: none"> <li>• Check if the ground cable connecting to the power supply is not broken and ensure that it's connected properly.</li> <li>• Check if the ground cable connecting to the workpiece is not broken and ensure that it's connected properly.</li> </ul>	Carry out daily inspection to extend the lifetime of the machine and to guarantee security.

# TROUBLESHOOTING

**Note :** The following operations must be carried out by a qualified electrician with valid certifications. Before maintenance, it is suggested you verify qualification.

Fault description	Measures to take
<p>The power indicator light is off. The fan is not on. There is no welding output.</p>	<ol style="list-style-type: none"> <li>1. Make sure that the power switch is turn on.</li> <li>2. Check if the power network works well.</li> <li>3. The heat variable resistors on the control panel is damaged. When this happens, the 24VDC general relay is open or the connectors are not connected properly.</li> <li>4. The control panel is damaged. There is no 310VDC output.               <ol style="list-style-type: none"> <li>(1) The silicone bridge is broken or the silicon bridge connector is not connected properly.</li> <li>(2) The power supply panel is burnt out.</li> <li>(3) Check the connections of the cable connecting the power switch with the control panel Check the connections of the cable connecting the control panel with the main control panel.</li> </ol> </li> <li>4. The main control panel's auxiliary power supply is damaged.</li> </ol>
<p>The power indicator light is on. The fan works properly. There is no welding output.</p>	<ol style="list-style-type: none"> <li>1. Check if all internal cables of the machine are well connected.</li> <li>2. The output connector is disconnected.</li> <li>3. The output connector is disconnected or not connected properly.</li> <li>4. The control circuit s damaged.</li> </ol>
<p>The power indicator light is on. The fan works properly. The fault indicator light is on.</p>	<ol style="list-style-type: none"> <li>1. The overheat protection may be activated. Turn off the power switch and restart the machine, once the fault indication light is off.</li> <li>2. The overheat protection may be activated. Wait 2-3 minutes.</li> <li>3. There may be a malfunction in the inverter circuit.</li> </ol>

 **WARNING**

The power must be cut off completely before starting any kind of inspection. Otherwise you may suffer serious accidents like electric shock or burns.





**LINLONG LIMITED**

[www.weldpro.com](http://www.weldpro.com)